

PROCEEDINGS OF SPIE

SPIDigitalLibrary.org/conference-proceedings-of-spie

20-W 1952-nm tandem hybrid single and double clad TDFA

Romano, Clément, Tench, Robert, Delavaux, Jean-Marc

Clément Romano, Robert E. Tench, Jean-Marc Delavaux, "20-W 1952-nm tandem hybrid single and double clad TDFA," Proc. SPIE 10512, Fiber Lasers XV: Technology and Systems, 105120Q (26 February 2018); doi: 10.1117/12.2290234

SPIE.

Event: SPIE LASE, 2018, San Francisco, California, United States

20 W 1952 nm Tandem Hybrid Single and Double Clad TDFA

Clément Romano^{*ab}, Robert E. Tench^a, Jean-Marc Delavaux^a

^aCybel LLC, 1195 Pennsylvania Avenue, Bethlehem, PA USA 18018; ^bInstitut Télécom/Télécom ParisTech, 46 Rue Barrault, 75013, Paris France

*clement.romano@cybel-llc.com, www.cybel-llc.com

ABSTRACT

A simple engineering design is important for achieving high Thulium-doped amplifier (TDFA) performance such as good power conversion, low noise figure (NF), scalable output power, high gain, and stable operation over a large dynamic range. In this paper we report the design, performance, and simulation of two stage high-power 1952 nm hybrid single and double clad TDFAs. The first stage of our hybrid amplifier is a single clad design, and the second stage is a double clad design. We demonstrate TDFAs with an output power greater than 20 W with single-frequency narrow linewidth (i.e. MHz) input signals at both 1952 and 2004 nm. An optical 10 dB bandwidth of 80 nm is derived from the ASE spectrum. The power stage is constructed with 10 μm core active fibers showing a maximum optical slope efficiency greater than 50 %. The experimental results lead to a 1 dB agreement with our simulation tool developed for single clad and double clad TDFAs. Overall this hybrid amplifier offers versatile features with the potential of much higher output power.

Keywords: Single frequency, fiber amplifier, Thulium, absorption, gain, multistage, simulation, single clad, double clad.

1. INTRODUCTION

The design of simple TDFA topology delivering high output power requires knowledge in three areas: first, a full assessment of the physical parameters of the doped fiber; second, an accurate simulation model for the amplifier; and third, a detailed comparison of experiment and simulation. We have already demonstrated with both single clad and double clad Thulium-doped fibers (TDF) that fundamental characterization of the active fiber, combined with a three level model, leads to good agreement between simulations and experimental data¹⁻³. Based on these results and our simulation software, we have developed a hybrid TDFA that provides broadband and high output power with a low noise figure and a large dynamic range. In this paper we report the design and performance of an optimized hybrid single/double clad TDFA operating in the 2 μm band. Our hybrid design delivers more than 20 W of output power over a bandwidth of 80 nm with more than 60 dB of signal gain and a noise figure below 6 dB. Comparison between simulation and experiment for the TDFAs shows good agreement with a difference smaller than 1 dB. We discuss also variations in the amplifier design with respect to optimization of output power, signal gain, noise figure, and optical bandwidth. Multiple topologies are investigated with the goal of optimizing and understanding the full potential of our tandem configuration.

2. FIBER CHARACTERISTICS AND SIMULATION

Regarding the simulation of the single clad (SCF) amplifier that we use as our pre-amplifier, extensive studies can be found in several publications²⁻⁴. The active fiber used is the single clad doped fiber from OFS, TmDF200: it has a core diameter of 4 μm and an NA of 0.26. We have characterized the ${}^3\text{F}_4 \leftrightarrow {}^3\text{H}_6$ transition, finding an absorption peak of 91 $\text{dB}\cdot\text{m}^{-1}$ at 1646 nm, a peak gain of 61 $\text{dB}\cdot\text{m}^{-1}$ at 1825 nm and a ${}^3\text{F}_4$ lifetime τ of 650 μs .

Regarding the double clad fiber simulation we have followed a similar approach where our simulation software relies on measurement of the fundamental characteristics of the active fiber. The main Thulium transition between the ground level ${}^3\text{H}_6$ and the first level ${}^3\text{F}_4$ was characterized for double clad fibers (DCF). The DCF used in our booster stage was a 10 μm core Thulium-doped fiber from iXBlue. It has an NA of 0.16, an octagonal clad shape and a clad absorption of 5 $\text{dB}\cdot\text{m}^{-1}$ at 790 nm according to its datasheet. The core absorption of double clad fibers was measured using a supercontinuum source with a cut-back method. The core gain of the DCF was measured through two different methods. The first is the saturated fluorescence technique⁵ which relies on observing the fluorescence of a short sample of active fiber which is fully inverted by an in-band pump. The second is based on direct measurement of gain at specific wavelengths around 2 μm ⁶.

Figure 1 shows the fitted absorption and gain curves of the iXBlue 10 μm core DCF. We observe a peak absorption of 370 $\text{dB}\cdot\text{m}^{-1}$ at 1650 nm and a peak gain of 240 $\text{dB}\cdot\text{m}^{-1}$ at 1820 nm for this fiber. The two methods used to measure the gain

show a good agreement at wavelengths between 1910 and 2050 nm. As with single-clad TDFs^{2,7}, the peak gain is smaller than the peak absorption.

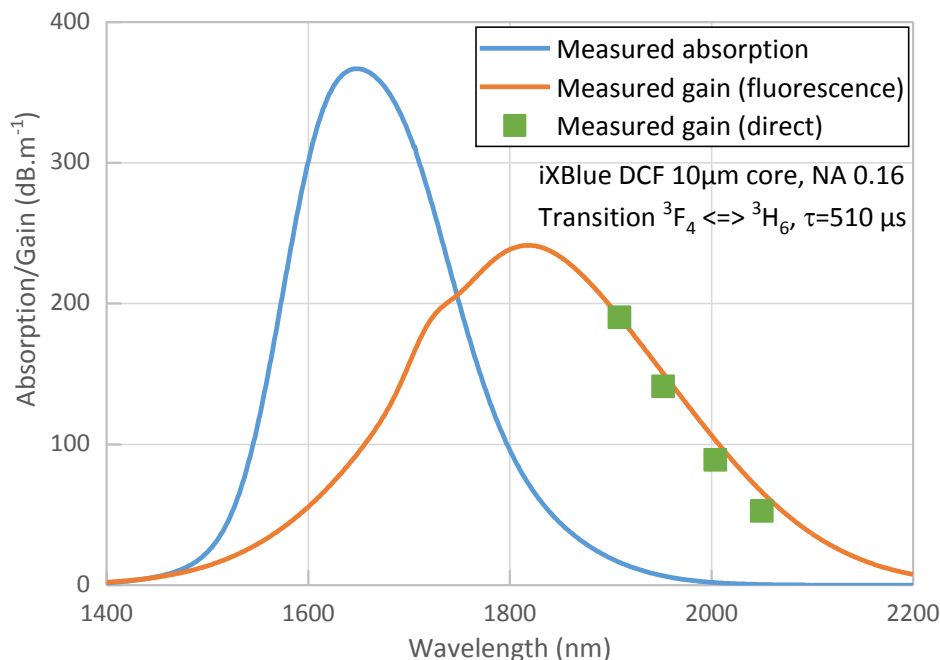

Figure 1: Absorption and gain for the ${}^3F_4 \leftrightarrow {}^3H_6$ transition, measured for iXBlue 10 μ m DCF.

We also measured the 3F_4 lifetime τ of the iXBlue DCF to be 510 μ s.

These measured parameters combined with values from the literature¹ were used in our simulation software to determine the fiber amplifier performance.

3. EXPERIMENTAL AMPLIFIER CONFIGURATION

The two stage amplifier topology is shown in Figure 2. Signal light from a single-frequency narrow linewidth discrete mode laser (DML) is coupled through an optical isolator into the first stage. This high gain stage is co- and counter-pumped with a multi-watt 1567 nm in-band fiber laser through a splitter. The fiber in the first stage is a single clad Thulium-doped fiber (OFS TmDF200, L=7 m). The output characteristics as a function of the coupling ratio of the splitter were studied and set to an optimum 50/50 split ratio for a total 1567 nm pump power of 2.8 W coupled into the active fiber⁴. The signal output of the first stage is coupled through an optical isolator into the second stage, which provides high output power through efficient pumping around 793 nm of a 5 m Thulium-doped DCF (iXBlue 10 μ m core). Input and output signal powers are measured internally: at the input and output of the active fibers. Pump powers stated are the values coupled into the Thulium-doped fibers.

In our series of measurements we considered first a counter-pumping configuration for the booster stage, and then compared our results with a co-pumping configuration.

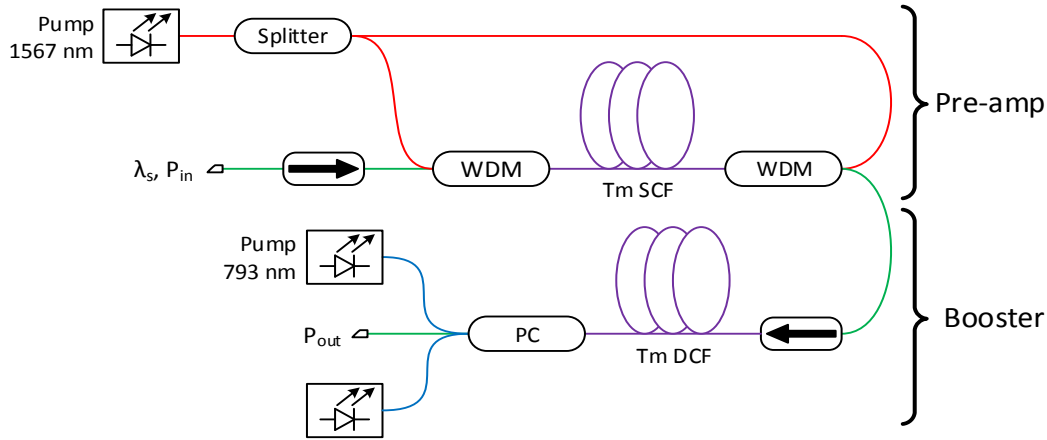

Figure 2: Topology of our two stage hybrid TDFA operating around 2 μm .

4. EXPERIMENTAL AND SIMULATED RESULTS

4.1 Pre-amplifier performance

The first stage was designed to be a pre-amplifier in the 1950 nm band. The output power (P_{out}) as a function of the pump power (P_{p}) is shown in Figure 3. The first stage is able to deliver more than a watt of output power for an input signal power (P_{in}) of 2 dBm. The optical to optical slope efficiency ($\eta_{\text{o-o}}$) which is defined as the variation of P_{out} relative to the variation of P_{p} , was measured to be 60 %. The simulation results of this amplifier yielded to a larger slope efficiency value of 73 %, which is 1 dB higher than our experimental data. At full pump power of 2.8 W the output power at 1952 nm is 1.6 W. The inset in Figure 3 shows that the simulated output spectrum (in orange) at full pump power predicts well our experimental spectrum (in blue). We observe an optical signal to noise ratio (OSNR) of 58 dB for both spectra. In order to determine the bandwidth of our amplifier we use a 10 dB criterion below the ASE peak and this indicates that our pre-amplifier exhibits a bandwidth of 120 nm.

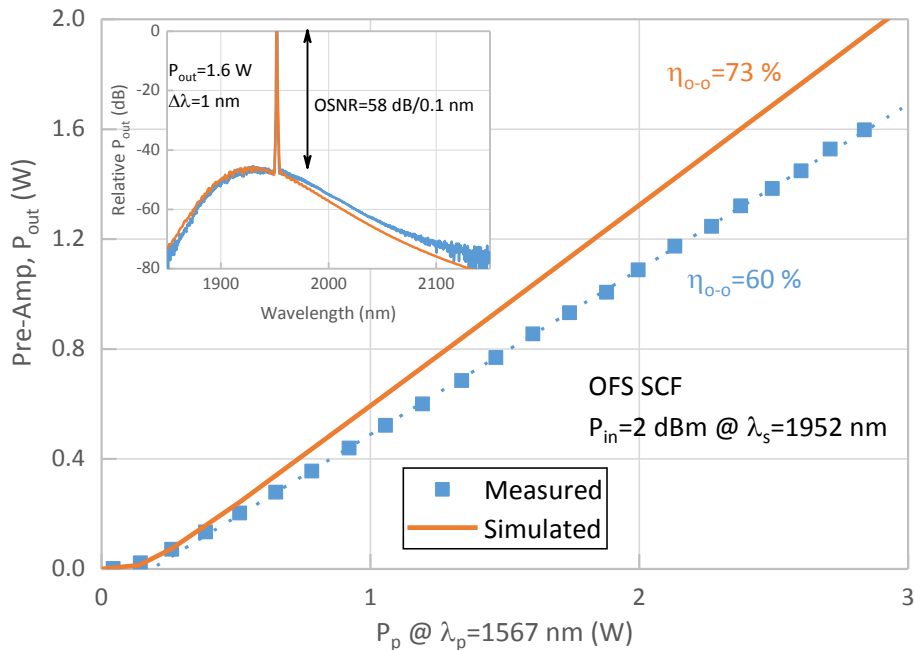

Figure 3: First stage output power at 1952 nm versus pump power.

An attenuator was included at the input of the amplifier to study the dependence of the amplifier on input signal power. Figure 4 shows the signal gain (G) and the noise figure (NF) as a function of P_{in} with its simulation. The amplifier demonstrates a dynamic range greater than 20 dB, limited by the onset of lasing. For an input signal power as small as -20 dBm, a gain greater than 45 dB and a noise figure of 3.3 dB were measured. The experimental signal gain and noise figure are in agreement with the simulation, within 1 dB accuracy.

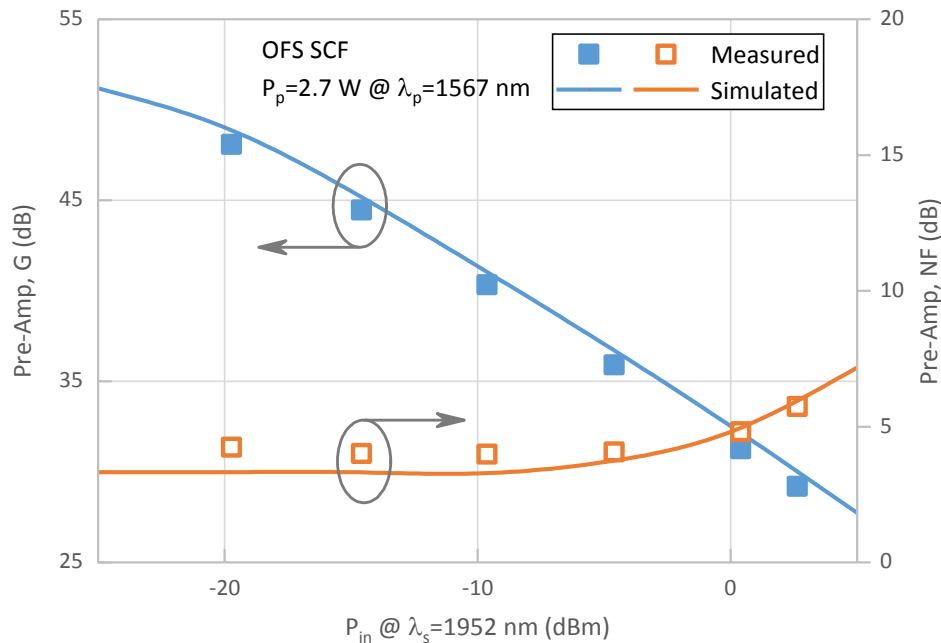

Figure 4: Gain and noise figure of the pre-amplifier versus input signal power at a pump power of 2.7 W.

To illustrate the broad bandwidth feature of our amplifier, Figure 5 shows the simulated dependence of optical slope efficiency η_{o-o} versus signal wavelength (λ_s) for $P_{in}=2$ dBm and a pump power below 1.5 W. Using a 50 % slope efficiency criterion, the simulation predicts a useful operating bandwidth of 170 nm for this amplifier. The 60 % data point at 1952 nm represents our pre-amplifier efficiency. A complete comparison between simulation and experiment can be found in reference ⁴.

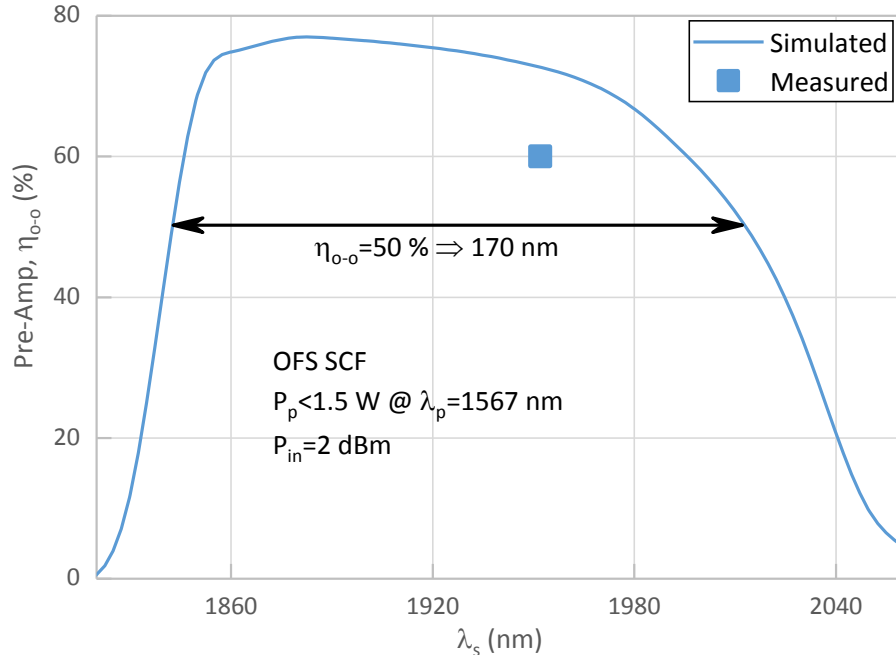

Figure 5: Optical slope efficiency versus signal wavelength: simulation and measurement.

In conclusion our single clad Tm-doped fiber pre-amplifier offers a combination of attractive features which include: signal gain greater than 40 dB, noise figure lower than 4 dB, an ASE 10 dB bandwidth of 120 nm, a 50 % slope efficiency bandwidth of 170 nm, and a saturated output power greater than 1.5 W.

4.2 Hybrid amplifier using the iXBlue fiber

Counter-pump configuration results

The topology displayed in Figure 2 was tested first with the booster stage in a counter-pumping configuration. Then we tested the booster stage in a co-pump configuration to compare the hybrid amplifier performance. Since the first stage was designed to have a broad operating wavelength bandwidth, we tested the performance of this hybrid amplifier at three different wavelengths: 1910, 1952, and 2004 nm. The output power at these three specific wavelengths as a function of the pump power is plotted in Figure 6 with the simulation at 1952 nm. The hybrid amplifier delivers more than 20 W of output power at 1952 nm and 2004 nm. In contrast, the hybrid amplifier performance at 1910 nm allows us to extract up to 7 W of P_{out} . Beyond this power, lasing at the peak of the ASE at 1970 nm due to high gain in the booster stage was observed. The simulation at 1952 nm, shown as an orange straight line, exhibits a slope efficiency of 58.7 %, slightly higher than the measured value of 51.5 %. At full pump power, the difference between the simulation and the experimental data is less than 1 dB, which is a good agreement and shows that our model can predict hybrid amplifier topology. We are currently investigating the reason for the 1 dB discrepancy. The inset in Figure 6 compares the simulated and measured output spectrum for a signal wavelength of 1952 nm and an output power of 21 W. The simulation and experimental results agree very well. We observe an OSNR of 57.6 dB for an input power of 2 dBm. From this ASE spectrum we estimate the amplifier transmission bandwidth using our 10 dB criterion to be 83 nm. This bandwidth although still quite broad is smaller when compared to the pre-amplifier bandwidth and it is centered at 1970 nm instead of 1930 nm.

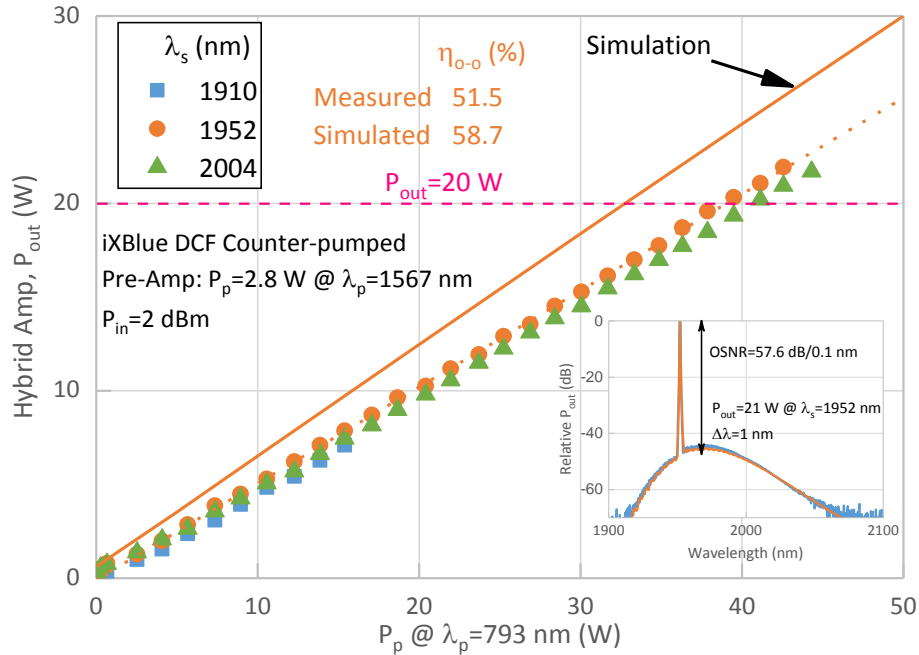

Figure 6: Output power at different wavelengths of the hybrid amplifier versus pump power. Booster stage counter-pumped.

Figure 7 shows the gain (G) and noise figure (NF) of the two stage hybrid amplifier for a booster stage counter-pumped for two levels of pump power. We define the dynamic range as the ratio between the maximum and the minimum input power without being limited by the onset of lasing of the amplifier or a nonlinear effect. Our DML limited us to a maximum input power of 2 dBm. With a pump power of 22 W the amplifier delivers 10 W of P_{out} over a dynamic range greater than 22 dB, while with 41 W of pump it delivers an output of 20 W over a dynamic range greater than 7 dB. The amplifier was limited by the lasing in the pre-amplifier stage because the interstage isolation wasn't enough to block the backward ASE from the booster stage to enter in the pre-amplifier stage. Over the whole P_{in} dynamic range the noise figure is lower than 6 dB.

The onset of lasing reduced the dynamic range to 7 dB. One obvious way to improve the dynamic range is to increase the isolation between the stages or use an ASE filter.

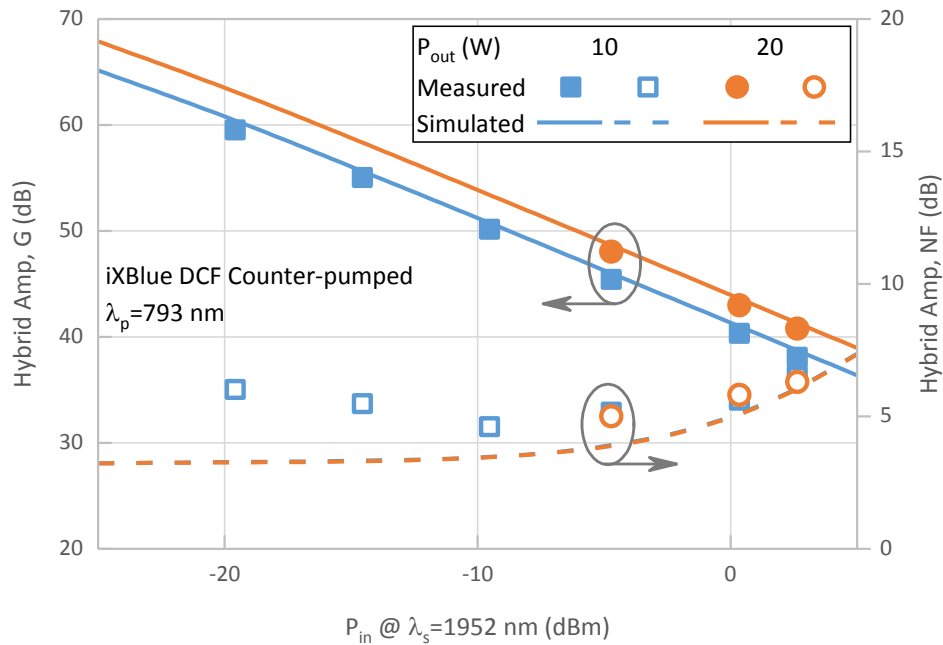

Figure 7: Gain and noise figure versus P_{in} for the hybrid amplifier based on counter-pumping the iXBlue fiber.

Co-pump configuration results

Next the hybrid amplifier was tested with its booster stage in a co-pumping setup. We first measured the output power versus pump power for a $P_{in}=2$ dBm at three different wavelengths. Figure 8 shows that we achieved more than 20 W of output power at 1952 nm and 2004 nm. As in counter-pump configuration the 1910 nm output power was limited to 7 W because of onset of lasing. The simulation and the measurement are in good agreement, with differences less than 1 dB, and exhibit an optical to optical slope efficiency smaller than in the counter-pumping configuration. The inset in Figure 8 shows the output spectrum at 2004 nm measured for an output power of 23.2 W. Again we found that our simulation matches well the measured spectrum. The 10 dB ASE criterion yields an operational bandwidth of 87 nm, comparable to bandwidth of the counter-pumping configuration.

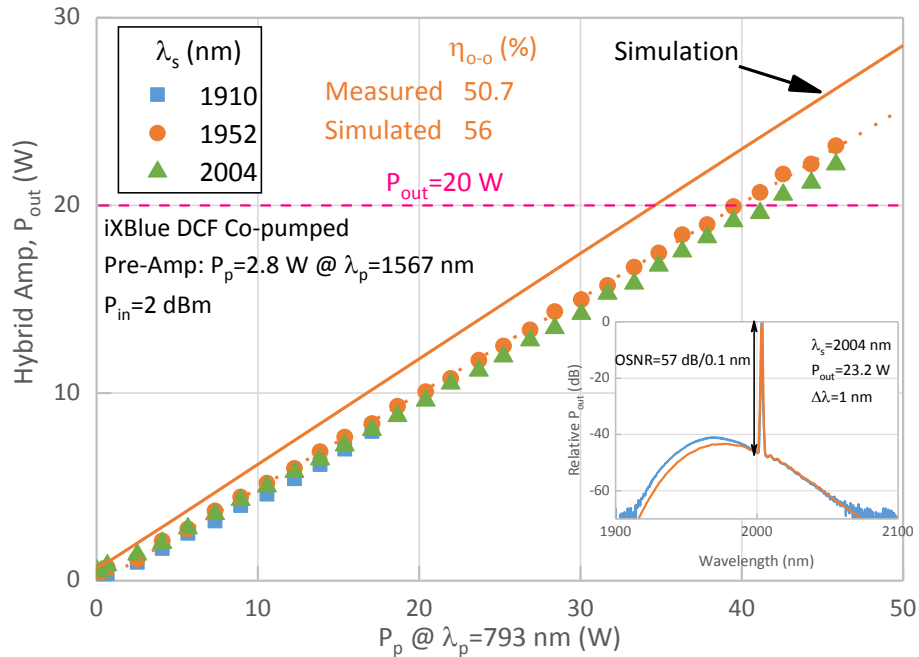

Figure 8: Output power at different wavelengths of the hybrid amplifier versus pump power. Booster stage co-pumped.

Figure 9 shows the dependence of gain and noise figure for two levels of pump power corresponding to an output power of 10 and 20 W respectively. Both gain and noise figure values for the co-pumping configuration are comparable to values obtained with the counter-pumping configuration. The major difference is the dynamic range which is increased from 7 to 12 dB for an output power of 20 W. Both experimental and simulated data are in good agreement, within a 1 dB accuracy.

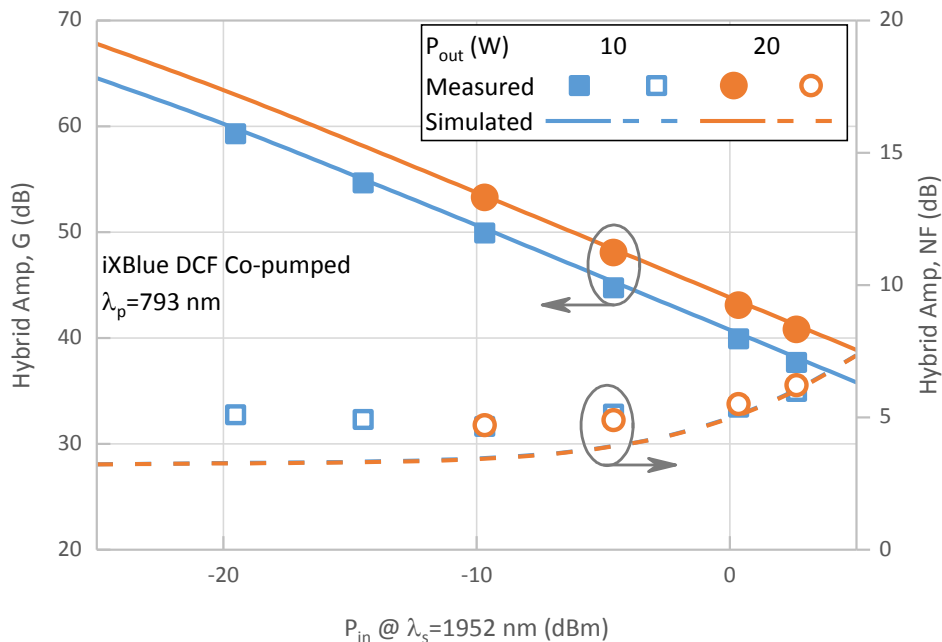

Figure 9: Gain and noise figure versus P_{in} for the hybrid amplifier based on co-pumping the iXBlue fiber.

In order to contrast the performance between co- and counter-pumping configurations of the booster stage and highlight the versatility of our simulation software, in Figure 10 we have plotted the gain and noise figure for both configurations as

a function of the pump power for $P_{in}=-10$ dBm. The performance of the two amplifier configurations overlap over the whole range of pump power. As far as the noise figure is concerned for both amplifier configurations its value remains below 5 dB over the pump range studied. The experimental data agree within 1 dB with the simulated results.

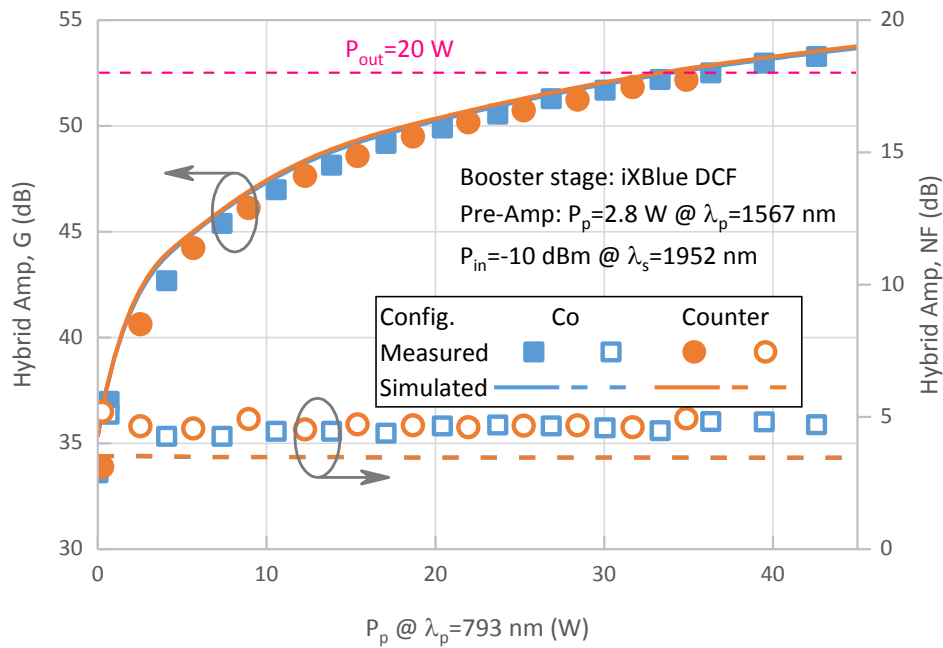

Figure 10: Gain and noise figure versus pump power for the hybrid amplifier based on iXBlue booster in co- and counter-pumping.

Finally to illustrate the power stability of the amplifier, we tracked the output power of the pre-amplifier and the hybrid amplifier separately at full pump power and $P_{in}=2$ dBm. This measurement is shown in Figure 10 and indicates that the output power stability is better than 2 % over a 3 hour period. No stimulated Brillouin scattering (SBS) was observed over the test period. This laser power measurement illustrate that our hybrid amplifier delivers steady performance.

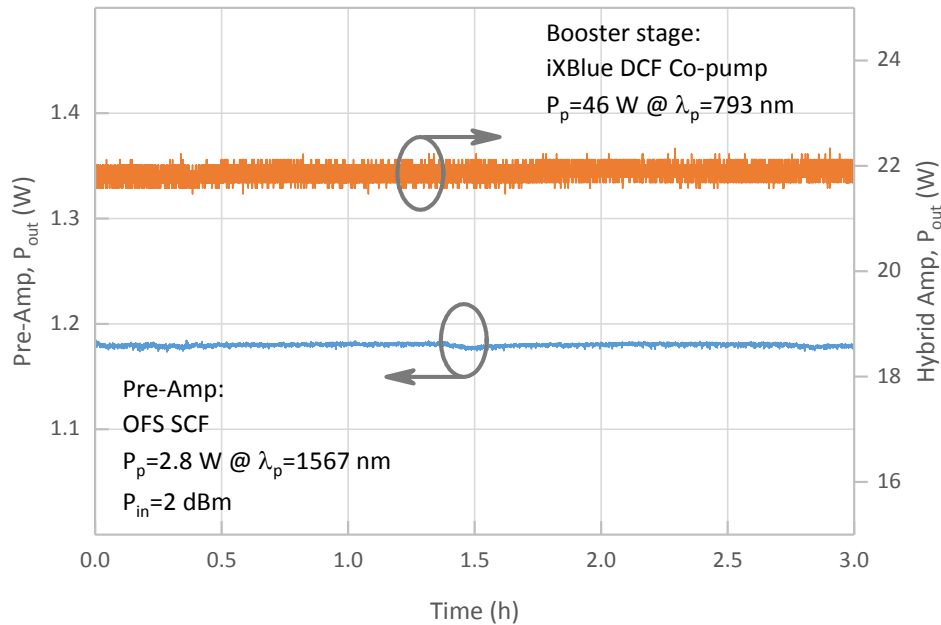

Figure 11: Power stability of the pre-amplifier and the hybrid amplifier at full pump power over three hours.

To summarize, we compare the performance of co- and counter-pumping hybrid configurations in Table 1. Both configurations can deliver an output power of 20 W with an optical slope efficiency of 50 % with an operational bandwidth greater than 80 nm centered at 1970 nm. As far as the input power dynamic range is concerned the co-pumped configuration offers a larger dynamic range of 12 dB compared to the 7 dB of the counter-pumped configuration.

Booster's iXBlue configuration	Co-pumped	Counter-pumped
P_{out} @ $P_p=42$ W, $P_{in}=2$ dBm (W)	21.7	21.9
10 dB bandwidth @ $P_p=42$ W (nm)	85	83
η_{o-o} @ $P_{in}=2$ dBm (%)	50.7	51.5
G @ $P_{in}=-10$ dBm, $P_p=23$ W (dB)	50.6	50.2
NF (dB)	< 6	
Dynamic range @ $P_{out}=20$ W (dB)	> 12	> 7
Dynamic range @ $P_{out}=10$ W (dB)	> 22	

Table 1: Performance of the hybrid amplifier with co- and counter-pumped configuration at $\lambda_s=1952$ nm.

4.3 Hybrid performance with Nufern fiber

In several publications, amplifiers made with 10 μm core DCF from Nufern^{8,9} have been demonstrated with an output power of 20 W or greater with a slope efficiency reported so far around 50 %. This Nufern fiber has a core diameter of 10.9 μm with an NA of 0.15 and a clad absorption of 4.7 $\text{dB}\cdot\text{m}^{-1}$ at 793 nm according to the datasheet. These characteristics are comparable to the iXBlue DCF. We are in the process of measuring the ${}^3\text{F}_4 \leftrightarrow {}^3\text{H}_6$ transition parameters for the Nufern fiber and this will be the subject of a forthcoming publication. A hybrid amplifier was assembled with its booster stage based on 5 m of Nufern fiber in a counter-pumping configuration. Below we present the output performance of such an amplifier.

As for the iXBlue fiber hybrid amplifier, we tested this configuration at two different wavelengths: 1952 nm and 2004 nm. The dependence of output power versus pump power for these wavelength is shown in Figure 12 with more than 20 W of output power for both signal wavelength. The measurement at 1910 nm signal wavelength was not possible since there was not enough gain at this wavelength in the booster stage. The optical to optical slope efficiency (η_{o-o}) measured value was the same for for both tested signal wavelength: 53.7 % which confirms the values found in the literature. The inset in Figure 12 shows measured output spectra for 1952 nm and 2004 nm at an output power of 21 W. For 1952 nm and 2004 nm we measured an OSNR of 58 and 59 dB respectively. The ASE spectrum, centered at 1980 nm, yields a 10 dB bandwidth of 71 nm.

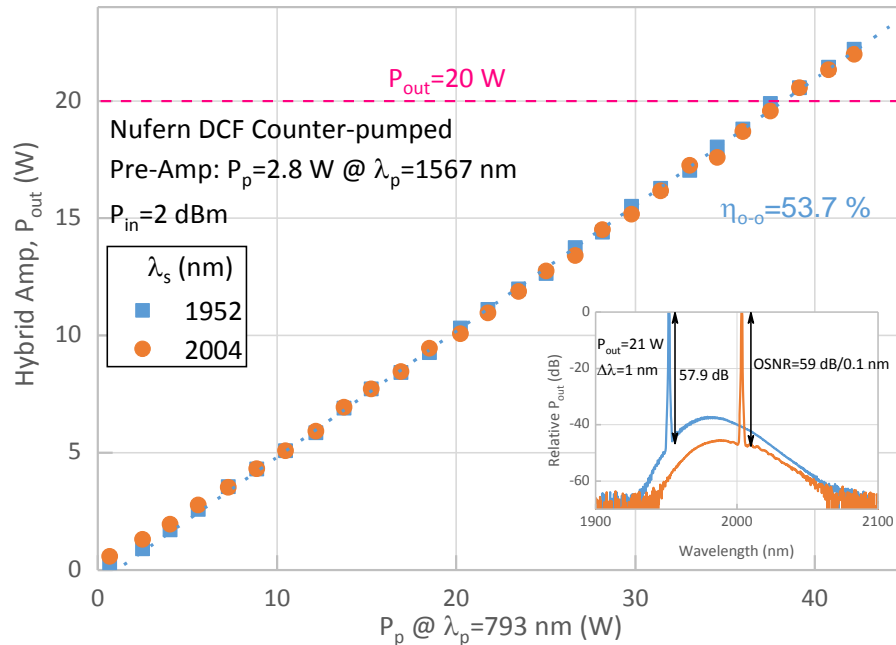

Figure 12: Output power versus pump power for the Nufern hybrid two stage amplifier.

Figure 13 shows the gain and noise figure versus pump power for $P_{in} = -10$ dBm at $\lambda_s = 1952$ nm for both Nufern and iXBlue fiber counter-pumped configuration. An exponential fit of the data is also graphed. The performance obtained for the two different fibers follow the same trend over the entire pump range. The only difference we could observe was the gain of the Nufern configuration was lower than the iXBlue by 1 dB.

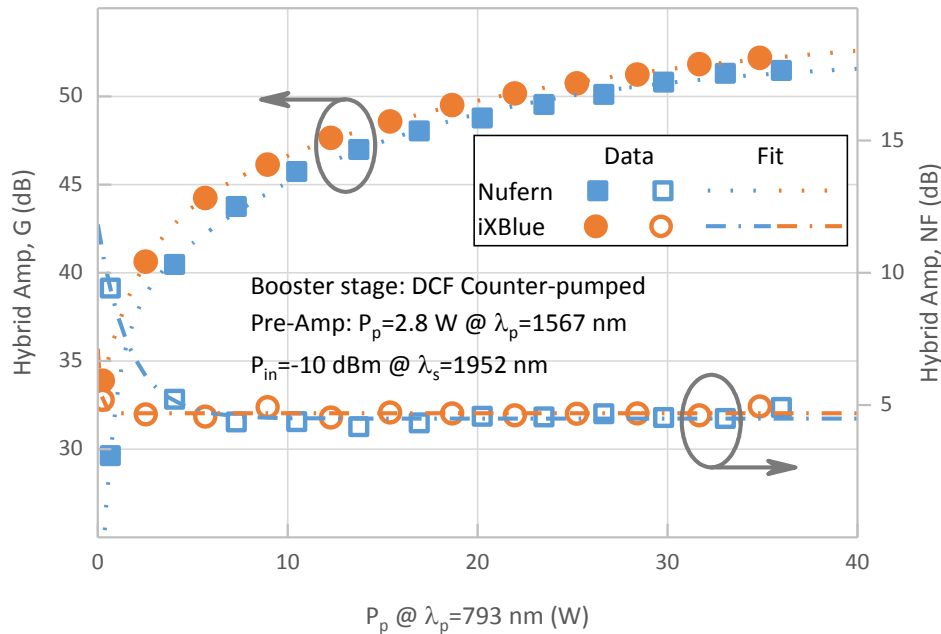

Figure 13: Gain and noise figure versus pump power for the hybrid amplifier with its booster active fiber as iXBlue or Nufern.

Overall the Nufern fiber performance is comparable with the iXBlue fiber and their performance is summarized in Table 2. Both configurations produce an output power greater than 20 W with a slope efficiency greater than 50% with a narrow linewidth source at 1952 nm and 2004 nm without presence of stimulated Brillouin scattering. The major difference between the two fibers was the operational bandwidth. The iXBlue fiber yielded a 83 nm bandwidth compared to a 70 nm bandwidth for the Nufern fiber. This bandwidth difference may find its origin in the fundamental parameters of the fiber.

Booster's DCF counter-pumped	iXBlue	Nufern
P_{out} @ $P_p=42$ W, $P_{in}=2$ dBm (W)	21.9	22.2
10 dB bandwidth @ $P_p=42$ W (nm)	83	71
η_{o-o} @ $P_{in}=2$ dBm (%)	51.5	53.7
G @ $P_{in}=-10$ dBm, $P_p=23$ W (dB)	50.2	49.5
NF (dB)	< 6	
Dynamic range @ $P_{out}=20$ W (dB)	> 22	
Dynamic range @ $P_{out}=10$ W (dB)	> 7	

Table 2: Summary of the characteristics of the hybrid two stage amplifier at $\lambda_s=1952$ nm with their booster based on iXBlue or Nufern fiber counter-pumped.

5. CONCLUSION

In this paper we have reported a simple two stage hybrid TDFA topology, that deliver more than 20 W of output power around 1952 nm. The first stage used an OFS single clad fiber core-pumped at 1567 nm, while the second stage used an iXBlue double clad fiber clad-pumped at 793 nm.

Two pumping configurations were investigated for the second stage: co- or counter-propagation. Each configuration was able to reach more than 20 W of output power over a 80 nm bandwidth with a slope efficiency greater than 50 %. Overall the performance for the co- and counter-pumped configurations is comparable, with co-pumping yielding better dynamic

range. For $P_{in} = -10$ dBm with the co-pumped configuration the signal gain was greater than 53 dB with a noise figure lower than 6 dB. An amplifier using a Nufern DCF was investigated, and its performance was found to be comparable to the iXBlue configuration, with the exception of the spectral bandwidth.

Our design was determined using our three level simulation software for TDFAs. In our comparisons of experiment and simulation the data agreed with the simulations within 1 dB accuracy demonstrating the versatility of our simulation software for both single clad and double clad TDFAs.

We note that in our experimental studies the booster stage was not limited by the pump power and no SBS or other nonlinear effects were observed. This indicates that the booster stage can be scaled to higher output power.

In summary, the simplicity, versatility, and high levels of performance of our hybrid SCF/DCF two stage TDFA make it an attractive candidate for multiple applications. These include in-line amplification in wideband optical transmission systems, LIDAR systems, and power boosting applications where output powers of 20 W and low noise figures of less than 6 dB are required.

6. ACKNOWLEDGEMENTS

We gratefully acknowledge iXBlue for the double clad TDF, OFS for the single clad TDF, Eblana Photonics for the single frequency DML sources around 2 μ m.

7. BIBLIOGRAPHY

- [1] Romano, C., Tench, R. E., Jaouën, Y., Williams, G. M., "Simulation and design of a multistage 10W thulium-doped double clad silica fiber amplifier at 2050nm," Fiber Lasers XIV Technol. Syst., SPIE Photonic West 100830H (2017).
- [2] Romano, C., Tench, R. E., Delavaux, J.-M., Jaouën, Y., "Characterization of the 3F4 – 3H6 Transition in Thulium-doped Silica Fibres and Simulation of a 2 μ m Single Clad Amplifier," ECOC, P1.SC1.2, Gothenburg (2017).
- [3] Tench, R. E., Romano, C., Delavaux, J.-M., "Broadband 2 W Output Power Tandem Thulium-doped Single Clad Fibre Amplifier for Optical Transmission at 2 μ m," ECOC, M.2.B.2, Gothenburg (2017).
- [4] Tench, R. E., Romano, C., Delavaux, J.-M., "Optimized Design and Performance of a Shared Pump Single Clad 2 μ m TDFA," Fiber Lasers XV Technol. Syst., SPIE Photonic West 10512-80 (2018).
- [5] Tench, R. E., Shimizu, M., "Fluorescence-based measurement of $g^*(\lambda)$ for erbium-doped fluoride fiber amplifiers," J. Light. Technol. **15**(8), 1559–1564 (1997).
- [6] Giles, C. R., Burrus, C. A., DiGiovanni, D. J., Dutta, N. K., Raybon, G., "Characterization of Erbium-Doped Fibers and Application to Modeling 980-nm and 1480-nm Pumped Amplifiers," IEEE Photonics Technol. Lett. **3**(4), 363–365 (1991).
- [7] Agger, S. D., Povlsen, J. H., "Emission and absorption cross section of thulium doped silica fibers," Opt. Express **14**, 50–57 (2006).
- [8] Ehrenreich, T., Khitrov, V., Frith, G., Farroni, J., Farley, K., Tankala, K., Carter, A., Christensen, S., Samson, B., et al., "High Efficiency 20W Single Frequency PM Fiber Amplifier at 2037nm," Adv. Solid-State Photonics (2009).
- [9] Engin, D., Chuang, T., Storm, M., "Compact, highly efficient, athermal, 25W, 2051nm Tm-fiber based MOPA for CO₂ trace-gas laser space transmitter," Fiber Lasers XIV Technol. Syst., SPIE Photonic West 10083-25 (2017).