



FEATURES

- High Bandwidth
- X-cut for high stability
- High optical power handling
- Low drive voltage
- Low insertion loss

APPLICATIONS

- Quantum optics
- 850 nm 100 GbE testing
- Pulse generation / picking

OPTIONS

- High extinction ratio > 30 dB
- Lower insertion loss
- 950 nm band modulators versions

RELATED EQUIPMENTS

- RF amplifiers
- MBC Automatic Bias Controllers
- NIR-MPX800 Phase Modulators
- ModBox-850nm-28Gb/s-NRZ

The NIR-MX800-LN series are 10 GHz and 20 GHz intensity modulators especially designed for operation in the 800 nm wavelength band.

NIR-MX800 Mach-Zehnder modulators offer engineers working in the 800 nm band the intrinsic and unparalleled benefits of LiNbO₃ modulation: high bandwidth, high contrast and ease of use.

NIR-MX800 series Intensity Modulators use proton exchange waveguide process on a doped LiNbO₃ substrat. This unique combination confers them an unparalleled stability and a superior optical power handling.

NIR-MX800-LN-10 Performance Highlights

Parameter	Min	Typ	Max	Unit
Operating wavelength	780	-	850	nm
Insertion loss	-	4.5	-	dB
Optical input power	-	-	14	dBm
Electro-optical bandwidth	-	12	-	GHz
V _π RF @50 kHz	-	3.5	-	V
Electrical return loss	-	12	-	dB

Specifications given at 25 °C, 780 nm or 850 nm

NIR-MX800-LN-20 Performance Highlights

Parameter	Min	Typ	Max	Unit
Operating wavelength	780	-	850	nm
Insertion loss	-	4.5	-	dB
Optical input power	-	-	14	dBm
Electro-optical bandwidth	-	25	-	GHz
V _π RF @50 kHz	-	3.5	-	V
Electrical return loss	-	12	-	dB

Specifications given at 25 °C, 780 nm or 850 nm

NIR-MX800-LN-10 10 GHz Intensity Modulator

Electrical Characteristics

Parameter	Symbol	Condition	Min	Typ	Max	Unit
Electro-optic bandwidth	S_{21}	RF electrodes, from 2 GHz	10	12	-	GHz
Ripple S_{21}	ΔS_{21}	RF electrodes, $f < 10$ GHz	-	0.5	1	dB
Electrical return loss	S_{11}	RF electrodes	-	-12	-10	dB
V_{π} RF @ 50 kHz	$V_{\pi RF_{50\text{ kHz}}}$	RF electrodes	-	3.5	4.5	V
V_{π} DC electrodes	$V_{\pi DC}$	DC electrodes	-	3.5	4.5	V
impedance matching	Z_{in-RF}	-	-	50	-	Ω
DC input impedance	Z_{in-DC}	-	-	1	-	$M\Omega$

Optical Characteristics

Parameter	Symbol	Condition	Min	Typ	Max	Unit
Crystal	-	-	Lithium Niobate X-Cut Y-Prop			
Operating wavelength	λ	-	780	800	850	nm
Insertion loss	IL	Without connectors	-	4.5	5.5	dB
DC extinction ratio	ER	Measured with narrow source linewidth < 200 MHz	20	22	-	dB
Optical return loss	ORL	-	-40	-45	-	dB
Chirp	α	-	-0.1	0	0.1	-

All specifications given at 25 °C, 780 nm or 850 nm.

Absolute Maximum Ratings

Parameter	Symbol	Min	Max	Unit
RF input power	EP_{in}	-	28	dBm
Bias voltage	V_{bias}	-20	+20	V
Optical input power	OP_{in}	-	14	dBm
Operating temperature	OT	0	+70	°C
Storage temperature	ST	-40	+85	°C

NIR-MX800-LN-20 20 GHz Intensity Modulator

Electrical Characteristics

Parameter	Symbol	Condition	Min	Typ	Max	Unit
Electro-optic bandwidth	S_{21}	RF electrodes, from 2 GHz	20	25	-	GHz
Ripple S_{21}	ΔS_{21}	RF electrodes, $f < 20$ GHz	-	0.5	1	dB
Electrical return loss	S_{11}	RF electrodes, $f < 20$ GHz	-	-13	-10	dB
V_{π} RF @ 50 kHz	$V_{\pi RF_{50\text{ kHz}}}$	RF electrodes	-	3.5	4.5	V
V_{π} DC electrodes	$V_{\pi DC}$	DC electrodes	-	3.9	4.5	V
impedance matching	Z_{in-RF}	-	-	50	-	Ω
DC input impedance	Z_{in-DC}	-	-	1	-	$M\Omega$

Optical Characteristics

Parameter	Symbol	Condition	Min	Typ	Max	Unit
Crystal	-	-	Lithium Niobate X-Cut Y-Prop			
Operating wavelength	λ	-	780	800	850	nm
Insertion loss	IL	Without connectors	-	4.5	5.5	dB
DC extinction ratio	ER	Measured with narrow source linewidth < 200 MHz	20	22	-	dB
Optical return loss	ORL	-	-40	-45	-	dB
Chirp	α	-	-0.1	0	0.1	-

All specifications given at 25 °C, 780 nm or 850 nm.

Absolute Maximum Ratings

Parameter	Symbol	Min	Max	Unit
RF input power	EP_{in}	-	28	dBm
Bias voltage	V_{bias}	-20	+20	V
Optical input power	OP_{in}	-	14	dBm
Operating temperature	OT	0	+70	°C
Storage temperature	ST	-40	+85	°C

NIR-MX800-LN-10 Typical S_{21} Curve

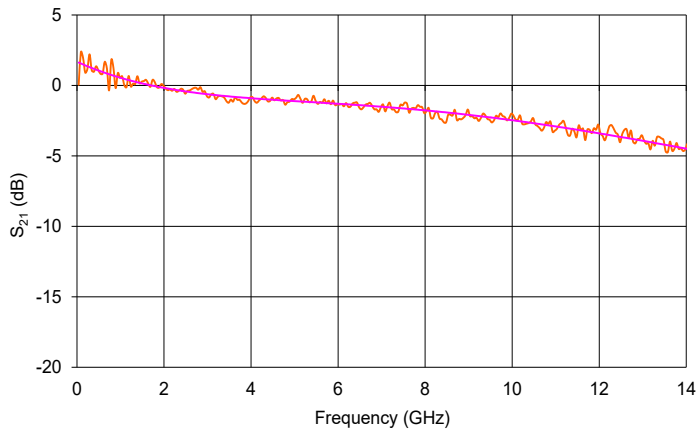

NIR-MX800-LN-10 Typical S_{11} Curve

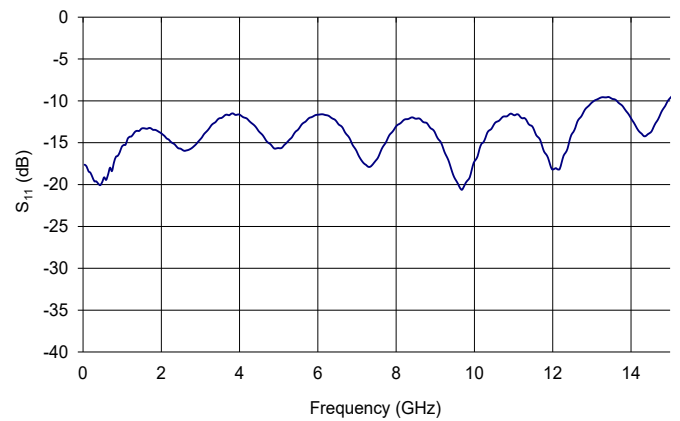

NIR-MX800-LN-20 Typical S_{21} Curve

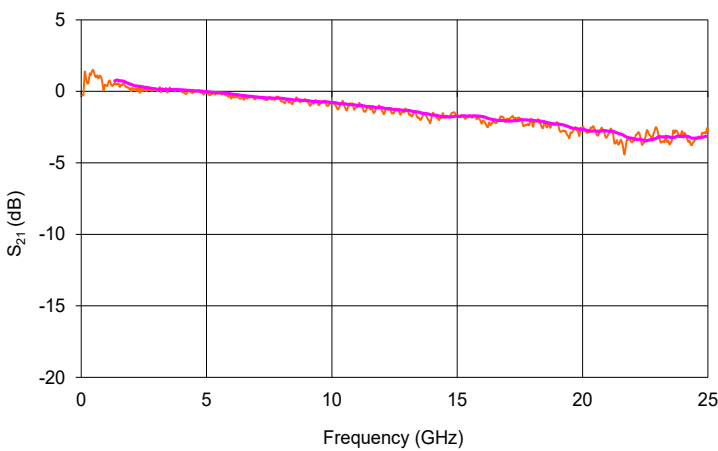

NIR-MX800-LN-20 Typical S_{11} Curve

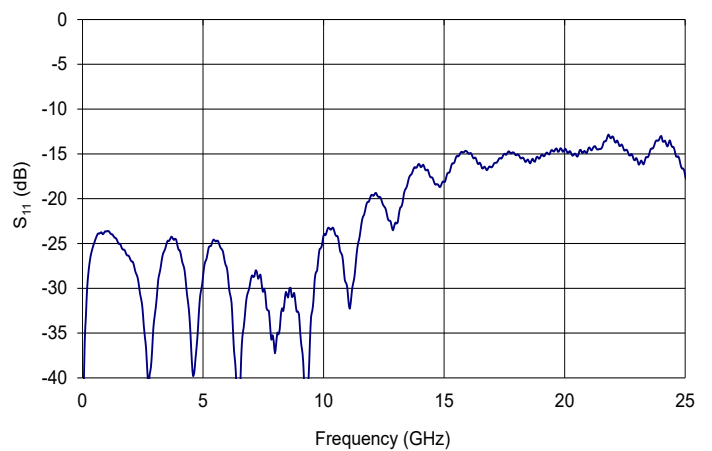

NIR-MX800-LN-20: 30 ps Square Pulse

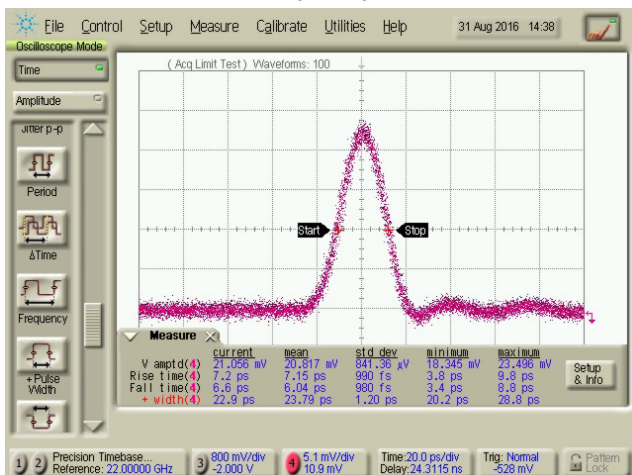

Stability with Time and Temperature

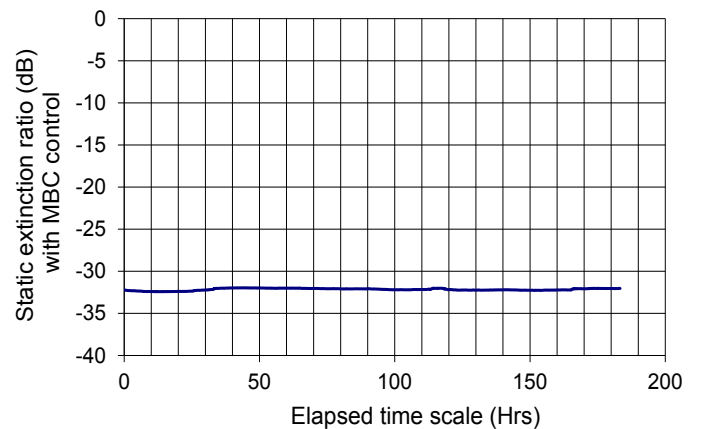

Mechanical Diagram and Pinout
All measurements in mm

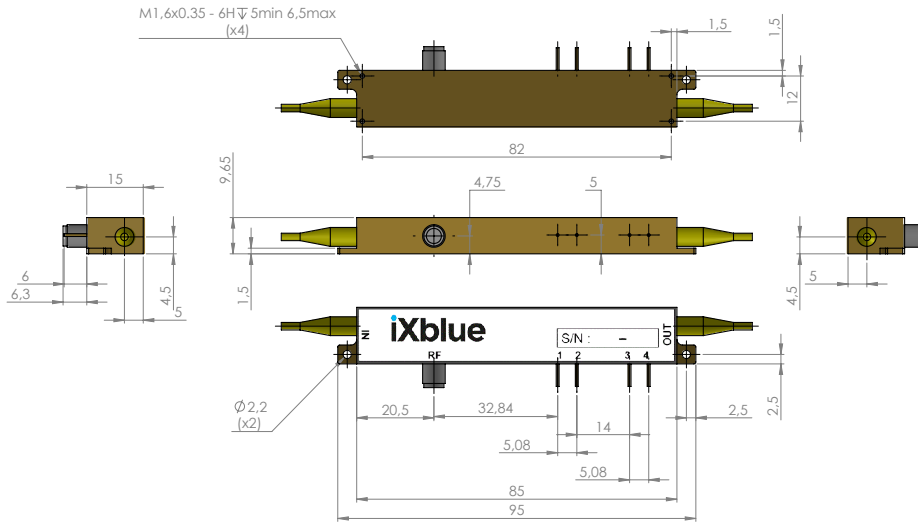

Port	Function	Note
IN	Optical input port	Polarization maintaining fiber, Corning PM 85-U25D, Length 1.5 meter. Buffer diameter 900 mm
OUT	Optical output port	Polarization maintaining fiber, Corning PM 85-U25D, Length 1.5 meter. Buffer diameter 900 mm
RF	RF input port	Wiltron female K
1	Ground	Pin feed through diameter 1.0 mm
2	DC	Pin feed through diameter 1.0 mm
3,4	Not connected	Pin feed through diameter 1.0 mm

Ordering information

NIR-MX800-LN-BW-00-Y-Z-AB-CD

BW = Bandwidth : 10 10 GHz 20 20 GHz
 00 = No monitoring PD
 Y = Input fiber : P Polarization maintaining
 Z = Output fiber : P Polarization maintaining
 AB = Input connector : 00 bare fiber FA FC/APC FC FC/SPC (slow axis parallel to connector key)
 CD = Output connector : 00 bare fiber FA FC/APC FC FC/SPC (slow axis parallel to connector key)
 Note : optical connectors are Senko with narrow key or equivalent

About us

ixblue Photonics produces specialty optical fibers and Bragg gratings based fiber optics components and provides optical modulation solutions based on the company lithium niobate (LiNbO₃) modulators and RF electronic modules.

ixblue Photonics serves a wide range of industries: sensing and instruments, defense, telecommunications, space and fiber lasers as well as research laboratories all over the world.

3, rue Sophie Germain
 25 000 Besançon - FRANCE
 Tel. : +33 (0)1 30 08 88 00 - Fax : + 33 (0) 1 30 08 88 88

ixblue reserves the right to change, at any time and without notice, the specifications, design, function or form of its products described herein. All statements, specification, technical information related to the products herein are given in good faith and based upon information believed to be reliable and accurate at the moment of printing. However the accuracy and completeness thereof is not guaranteed. No liability is assumed for any inaccuracies and as a result of use of the products. The user must validate all parameters for each application before use and he assumes all risks in connection with the use of the products