

## MODULATOR

# NIR-MX950-LN-20

## 950 nm band 20 GHz Intensity Modulators

The NIR-MX950-LN-20 is a 20 GHz intensity modulator especially designed for operation in the 950 nm wavelength band.

NIR-MX950 Mach-Zehnder modulators offer engineers working in the 950 nm band the intrinsic and unparalleled benefits of LiNbO<sub>3</sub> modulation: high bandwidth, high contrast and ease of use.

NIR-MX950-LN-20 Intensity Modulators use proton exchange waveguide process on a doped LiNbO<sub>3</sub> substrat. This unique combination confers them an unparalleled stability and a superior optical power handling.

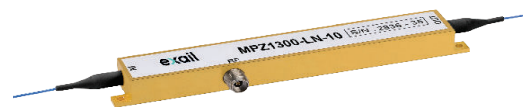

### Features

- High Bandwidth
- X-cut for high stability
- High optical power handling
- Low drive voltage
- Low insertion loss

### Applications

- Quantum optics
- Pulse generation / picking

### Options

- 950 nm band modulators versions

### Related Equipments

- RF amplifiers
- MBC Automatic Bias Controllers
- NIR-MPX950 Phase Modulators

### NIR-MX950-LN-20 Performance Highlights

Parameter	Min	Typ	Max	Unit
Operating wavelength	850	900	960	nm
Insertion loss	-	5.5	-	dB
Optical input power	-	-	14	dBm
Electro-optical bandwidth	-	25	-	GHz
V <sub>π</sub> RF @50 kHz	-	3.5	-	V
Electrical return loss	-	12	-	dB

Specifications given at 25 °C, 950 nm

# NIR-MX950-LN-20

## 20 GHz Intensity Modulator

### Electrical Characteristics

Parameter	Symbol	Condition	Min	Typ	Max	Unit
Electro-optical bandwidth @-3 dB	$S_{21}$	RF electrodes, from 2 GHz	20	25	-	GHz
Ripple $S_{21}$	$\Delta S_{21}$	RF electrodes, $f < 20$ GHz	-	0.5	1	dB
Electrical return loss	$S_{11}$	RF electrodes, $f < 20$ GHz	-	-13	-10	dB
$V_{\pi}$ RF @50 kHz	$V_{\pi_{RF\ 50\ kHz}}$	RF electrodes	-	3.5	4.5	V
$V_{\pi}$ DC electrodes	$V_{\pi_{DC}}$	DC electrodes	-	3.9	4.5	V
Impedance matching	$Z_{in-RF}$	-	-	50	-	$\Omega$
DC input impedance	$Z_{in-DC}$	-	-	1	-	M $\Omega$

### Optical Characteristics

Parameter	Symbol	Condition	Min	Typ	Max	Unit
Crystal	-	-	Lithium Niobate X-Cut Y-Prop			
Operating wavelength	$\lambda$	-	850	900	960	nm
Insertion loss	IL	Without connectors*	-	5.5	-	dB
DC extinction ratio	ER	Measured with narrow source linewidth $< 200$ MHz	20	25	-	dB
Optical return loss	ORL	-	-40	-45	-	dB
Chirp	$\alpha$	-	-0.1	0	0.1	-

All specifications given at 25 °C, 944 nm

\*Consider an extra-loss up to 0.6 dB for each FC/APC optical connector

### Absolute Maximum Ratings

Stresses in excess of the absolute maximum ratings can cause permanent damage to the device. These are absolute stress ratings only. Functional operation of the device is not implied at these or any other conditions in excess of those given in the operational sections of the data sheet. Exposure to absolute maximum ratings for extended periods can adversely affect device reliability.

Parameter	Symbol	Min	Max	Unit
RF input power	$EP_{in}$	-	28	dBm
Bias Voltage	$V_{bias}$	-20	+20	V
Optical input power	$OP_{in}$	-	14	dBm
Operating temperature	OT	0	+70	°C
Storage temperature	ST	-40	+85	°C

# NIR-MX950-LN-20

NIR-MX950-LN-20 Typical  $S_{21}$  Curve

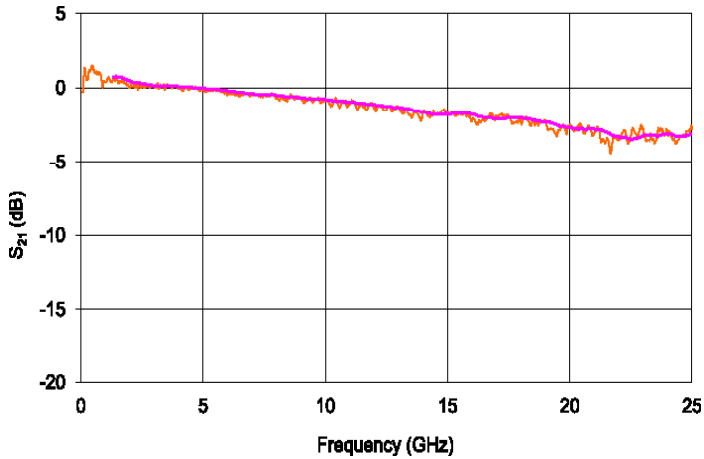

NIR-MX950-LN-20 Typical  $S_{11}$  Curve

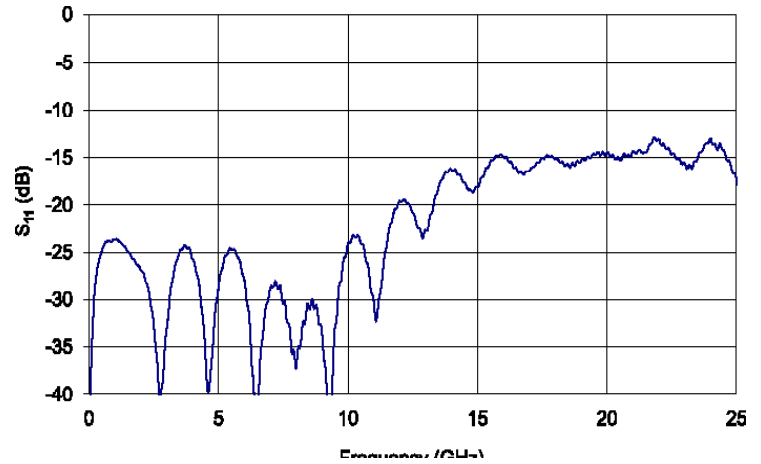

NIR-MX950-LN-20: 30 ps Square Pulse

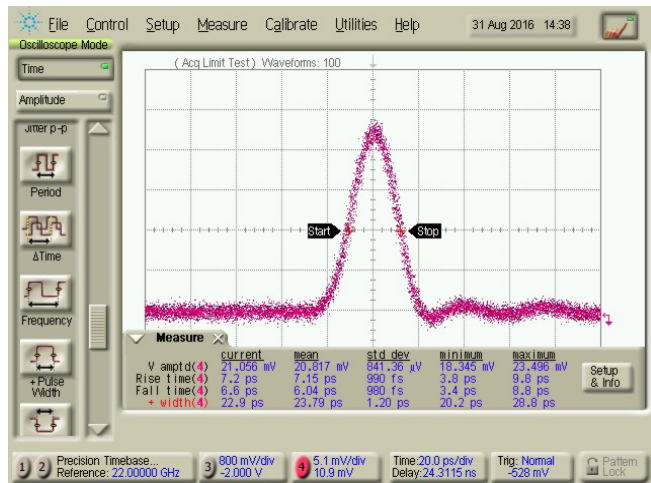

Stability with Time and Temperature

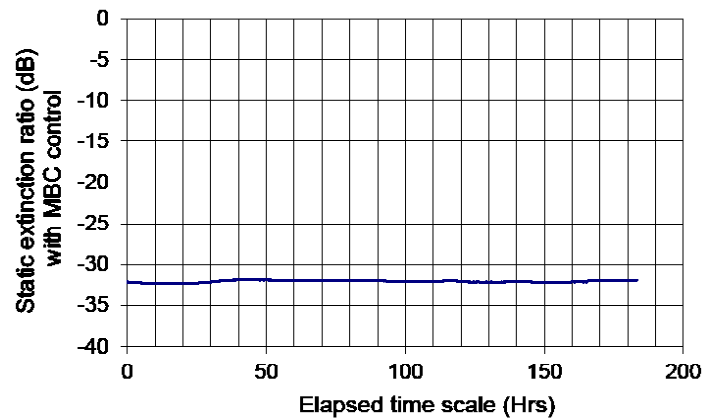

# MODULATOR | NIR-MX950-LN-20 | 4/4

## Mechanical Diagram and Pinout

All measurements in mm

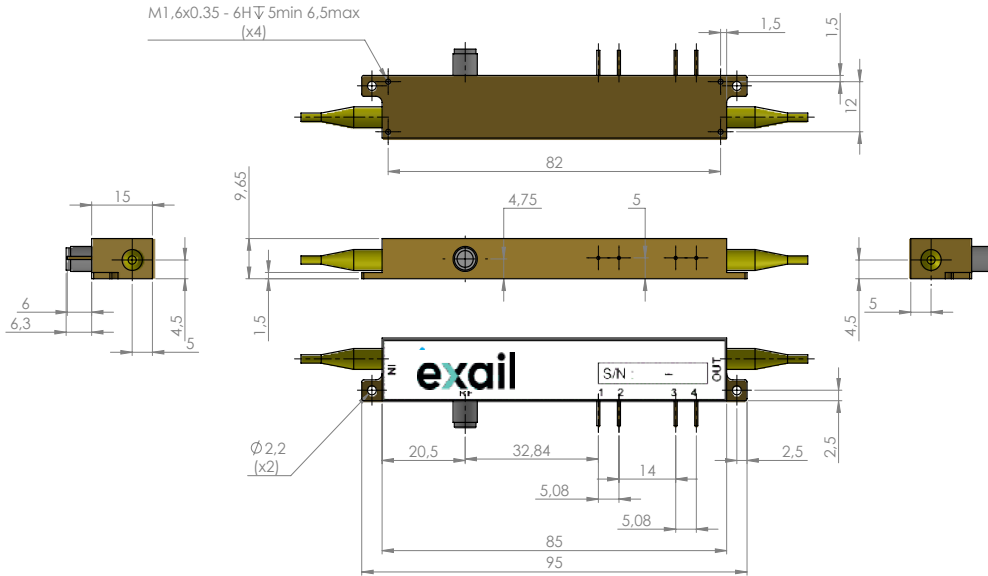

Port	Function	Note
IN	Optical input port	Polarization maintaining fiber Corning PM 85-U25D Length: 1.5 meter, buffer diameter: 900 µm
OUT	Optical output port	Polarization maintaining fiber Corning PM 85-U25D Length: 1.5 meter, buffer diameter: 900 µm
RF	RF input port	Female K
1	Ground	Pin feed through diameter 1.0 mm
2	DC	Pin feed through diameter 1.0 mm
3, 4	Photodiode cathode, anode	Pin feed through diameter 1.0 mm

## Ordering information

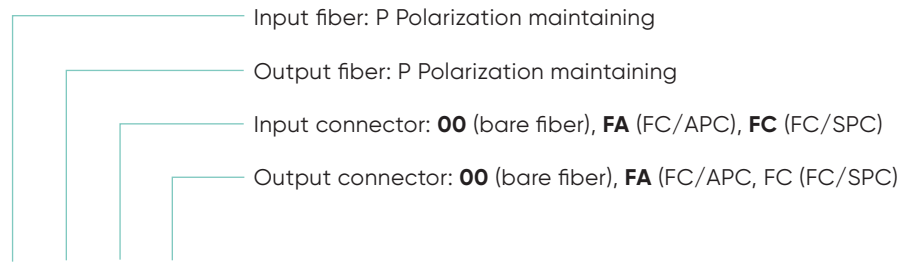

NIR-MX950-LN-20-00 - □-□-□-□

## About us

Exail Photonics produces specialty optical fibers and Bragg gratings based fiber optics components and provides optical modulation solutions based on the company lithium niobate (LiNbO<sub>3</sub>) modulators and RF electronic modules. Exail Photonics serves a wide range of industries: sensing and instruments, defense, telecommunications, space and fiber lasers as well as research laboratories all over the world.

Exail reserves the right to change, at any time and without notice, the specifications, design, function or form of its products described herein. All statements, specification, technical information related to the products herein are given in good faith and based upon information believed to be reliable and accurate at the moment of printing. **However, Exail provides no warranty (whether express or implied or statutory) as to the description, sufficiency, accuracy or completeness, merchantability or fitness for a particular purpose of any information or specification detailed herein.** No liability is assumed for any inaccuracies and/or as a result of use of the products. The user must validate all parameters for each application before any use and he shall assume all risks and responsibilities in connection with the use of the products.